

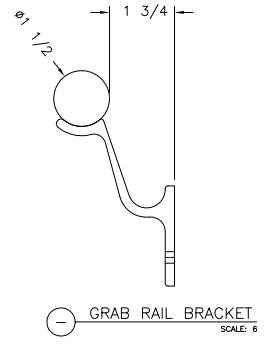

WORLD CLASS ARCHITECTURAL PRODUCTS

HANSEN
ARCHITECTURAL
SYSTEMS

5500 SE ALEXANDER ST. HILLSBORO OR. 97123
PH. 503-356-0959 FAX 503-356-8478

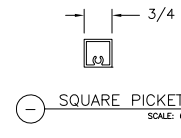
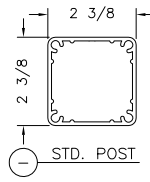
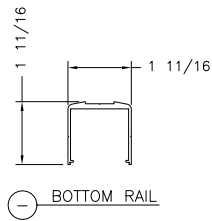
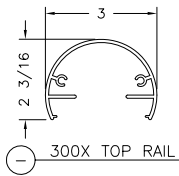
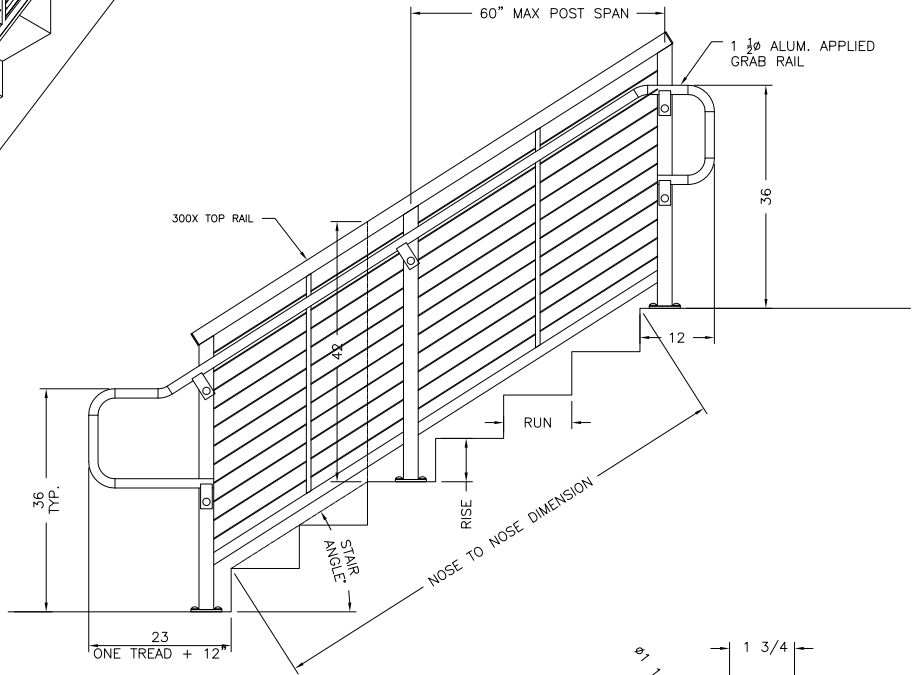
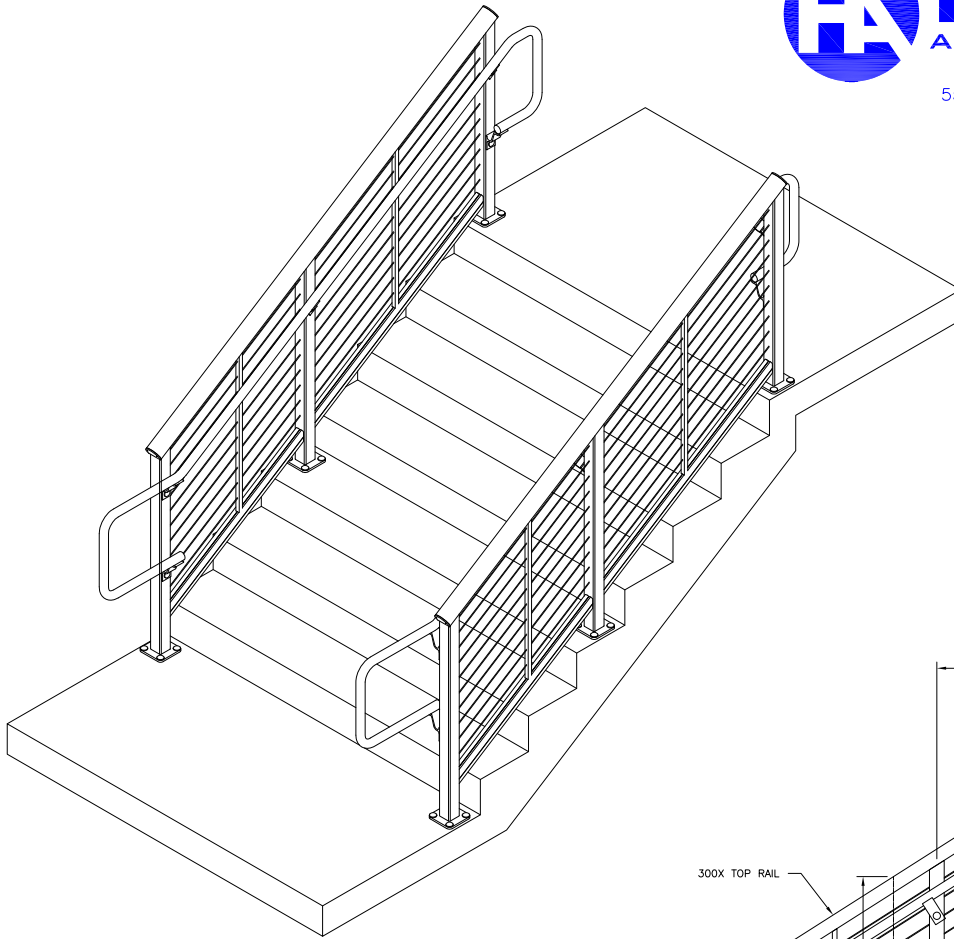

CABLE STAIR RAILING WITH GRAB RAIL
www.aluminumrailing.com